

# ÉCLIPSE

DESIGNED BY HERVÉ LANGLAIS

Série d'appliques déclinée en deux diamètres, *Éclipse* joue de disparition entre sa dalle de led et ses deux disques de laiton. Un objet céleste qui ensoleille les architectures.



*Éclipse*, a wall light available in two diameters in which a led plate is hidden in between two brass discs. A celestial object that stuns architectures.



**Finitions  
Finishes** ①+②

 Laiton satiné	 Graphite satiné	 Nickel satiné	 Cuivre satiné
<b>SB</b> Satin brass	<b>SG</b> Satin graphite	<b>SN</b> Satin nickel	<b>SC</b> Satin copper

En standard, le petit disque au centre du produit sera toujours en finition (①) polie.  
Si vous préférez une finition satinée, merci de le préciser.  
The small centered disc on the front always comes in a polished finish (①) but can be in satin if specified.

**Matériaux  
Material**

Laiton massif  
Solid Brass

**Description  
Features**

L'applique *Éclipse* est fixe. Une fois positionnée au mur, elle ne peut pas tourner.  
Please be aware that discs are fixed and cannot be positioned in any other way.

**Source  
Lamping**

LED intégrée	1790 lm	3000°K	Alim. électronique intégrée	Variation (phase cut)
Integrated LED	1790 lm	3000°K	Integrated power supply	Dimmable (phase cut)

**Designer**

Hervé Langlais

**Éclipse XL**

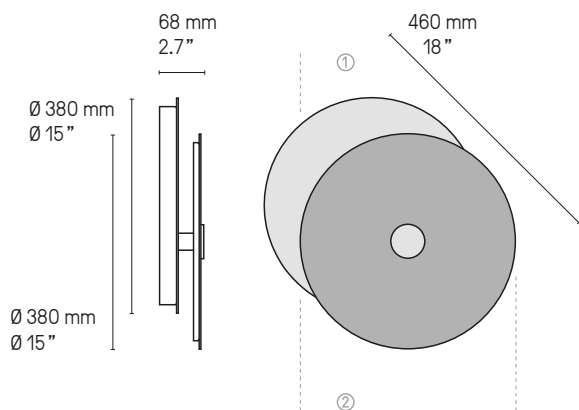

**Éclipse XS**

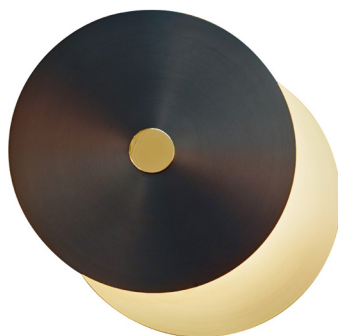
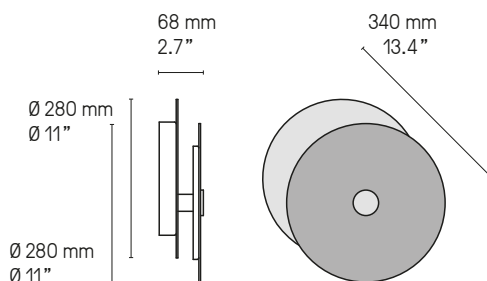

Eclipse XL SB/SG





Eclipse XS + XL SB/SB

## NUANCIER - FINISH OPTIONS



### LAITON - BRASS

- |                                     |   |
|-------------------------------------|---|
| ① Laiton satiné<br>SB Satin brass   | ② Graphite satiné<br>SG Satin graphite  |
| ③ Nickel satiné<br>SN Satin nickel  | ④ Cuivre satiné<br>SC Satin copper      |
| ⑤ Laiton poli<br>PB Polished brass  | ⑥ Graphite poli<br>PG Polished graphite |
| ⑦ Nickel poli<br>PN Polished nickel | ⑧ Cuivre poli<br>PC Polished copper     |

### ABAT-JOURS - LAMPSHADES

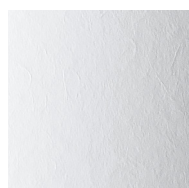

Drop Paper® 100



Drop Paper® 101

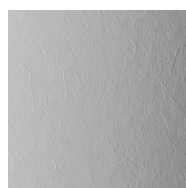

Drop Paper® 103



Chinette blanche  
White chinette

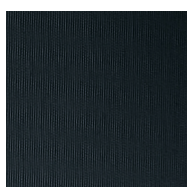

Chinette noire  
Black chinette

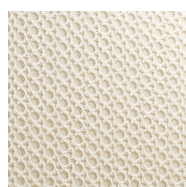

Duke  
Duke

### CÂBLES - CABLES

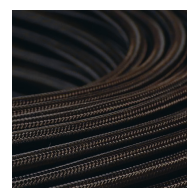

Tissu noir  
Black textile



Tissu or  
Gold textile

### VERRERIE - GLASS



Opale  
Opal

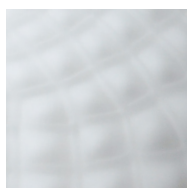

Opale et écaille  
Opal and patterned



Claire et écaille  
Clear and patterned





© Yannick Labrousse

## CVL LUMINAIRES

79 ROUTE DE LA CHEVALLERIE – 49770 LONGUENÉE-EN-ANJOU – FRANCE

TEL. +33 (0) 2 41 32 67 54

EMAIL : CONTACT@CVL-LUMINAIRES.FR

**WWW.CVL-LUMINAIRES.FR**

Brand identity & art direction: [POOL](#) Layout & production supervision: [deuxpointdeux](#)  
Texts: [Valérie Marion](#) Translation: [CVL](#) Photos: [Garnier Studios](#) except when mentioned otherwise 3D: [CVL](#) except when mentioned otherwise

Make sure to download our latest catalogue [here](#)